

DAC60000 SERIES

24VDC Inverters with High Intelligence



*Parallel connectable 600VA ... 14 kVA
Redundant n+1 system, hot swap modules
Both On-line and Off-line applications*



Stand alone applications 600VA ... 1200VA

- Real redundant, Fault tolerant system • Small size, light weight, standard 19" rack
- High efficiency • High overload capability • User programmable features
- Remote monitoring through RS-232 with standard PC



POWERNET

**POWER
PARTNER**

Sales & R&D: Mäkituvantie 3 H, FIN-01510 VANTAA, Tel. +358 9 8362 830, Fax +358 9 8362 8362
 Production and Service: Teollisuuskatu 3, FIN-44150 ÄÄNEKOSKI, Tel. +358 14 3396 400, Fax +358 14 3396 410
 E-mail: marketing@powernet.fi, service@powernet.fi, Internet: www.powernet.fi

STAND ALONE INVERTERS						
Type	DC input Range	Nominal AC output	Nominal Power	Cooling	Dimensions Without handles	Weight
DAC60132VF	20...32VDC	230VAC, 50Hz	1000VA/600W	Convection	14TE x 6U x 372mm	4 kg
DAC60232VF	20...32VDC	230VAC, 50Hz	1200VA/800W	Forced, fan	14TE x 6U x 372mm	4 kg
MSR7990+DAC60232VF	20...32VDC	230VAC, 50Hz	1200VA/800W	Forced, fan	19" x 2U x 372mm	4,5 kg
ADU68230+DAC60232VF *)	20...32VDC	230VAC, 50Hz	1200VA/800W	Forced, fan	19" x 2U x 372mm	4,5 kg
DAC60012VF	20...32VDC	115VAC, 60Hz	600VA/600W	Convection	14TE x 6U x 372mm	4 kg

*) Includes AC distribution 4 x MCB

PARALLEL CONNECTABLE INVERTERS						
Type	DC input Range	Nominal AC output	Nominal Power	Cooling	Dimensions Without handles	Weight
DAC62132VF	20...32VDC	230VAC, 50Hz	1000VA/600W	Convection	14TE x 6U x 372mm	4 kg
DAC62232VF	20...32VDC	230VAC, 50Hz	1200VA/800W	Forced, fan	14TE x 6U x 372mm	4 kg
MSR7990+DAC62232VF	20...32VDC	230VAC, 50Hz	1200VA/800W	Forced, fan	19" x 2U x 372mm	4,5 kg
ADU68230+DAC62232VF *)	20...32VDC	230VAC, 50Hz	1200VA/800W	Forced, fan	19" x 2U x 372mm	4,5 kg
DAC62012VF	20...32VDC	115VAC, 60Hz	600VA/600W	Convection	14TE x 6U x 372mm	4 kg

*) Includes AC distribution 4 x MCB

STATIC SWITCH + MANUAL BYPASS	
Type	Description
BPU69130VF	External static switch, 6000VA 230VAC, 14TE x 6U x 372mm module
MSR7990+BPU69130VF	External static switch, 6000VA 230VAC, 19" x 2U x 372mm
BPU69010VF	External static switch, 3000VA 115VAC, 14TE x 6U x 372mm module
MSR7990+BPU69010VF	External static switch, 3000VA 115VAC, 19" x 2U x 372mm

MBP68000 / MBP68200 See separate datasheets for 6U and 2U manual bypass solutions

ACCESSORIES	
Type	Description
WMA7830	Wall mounting adapter for 6U 14TE inverter, 1-3 modules can be mounted to one compact package
68200014	19" Subrack 6U 300mm for 1-6pcs of 14TE 6U models (note inverter's depth 372mm)
68200016	Wall mountable 19" Subrack 6U 475mm for 1-6pcs of 14TE 6U models, open construction
8868000	Wall mountable 19" Subrack 7U 475mm for 1-6pcs of 14TE 6U models, shielded enclosure
8860000C	Coverplate set for empty module place in 19" 6U subrack
8760037A	Remote monitoring software in CD and RS232 cable between DAC60000 inverter and Computer
8760038C	Parallel connecting cable, 2-6pcs of inverters or static switch and 1-5pcs of inverters
8760039A	Power cable between static switch and inverter
SPCPDU-3	Parallel connection unit for 6pcs of DAC60000 inverters and IEC320 AC-distribution

AC-DISTRIBUTION	
Series	Description
MBP68000 / MBP68200	See separate datasheets for 6U and 2U AC-distribution units
SPC PDUs	See separate datasheets for IEC320 connector based 19" 1U distribution units

The Inverter packing includes following:

- 1) Inverter
- 2) AC output connector (finger protected screw terminals)
- 3) DC input cable 3m 10mm²
- 4) User manual
- 5) Grounding cable 3m 10mm²

The Static Switch packing includes:

- 6) Static Switch
- 7) Mains Input cable 2m 4,5 mm²
- 8) AC output cable 2m 4,5 mm²
- 9) Grounding cable 2m 6mm²

To be ordered separately

- 10) RemoteMonitor software in CD and Remote monitoring cable PC-Inverter(s)
- 11) Parallel connecting cable for 2-6 modules
- 12) Power cable static switch – inverters 1m 1,5 mm²

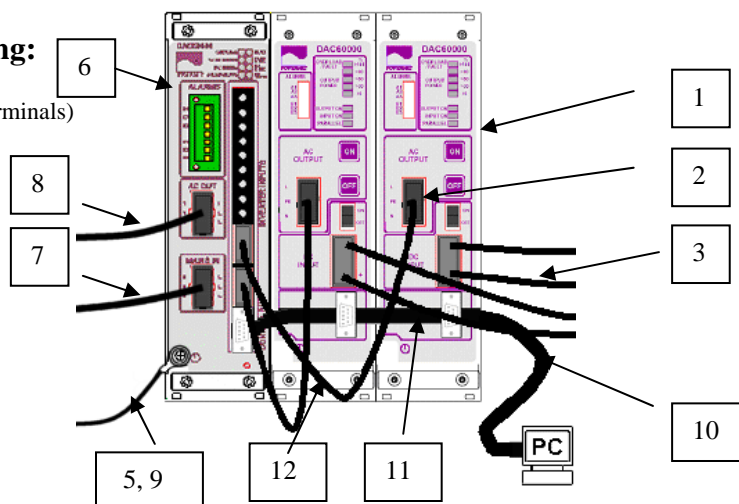

SPECIFICATION INVERTERS	24VDC / 230VAC 1000VA	24VDC / 230VAC 1200VA	24VDC / 115VAC 600VA
ELECTRICAL			
Input voltage	20-32 VDC User programmable (PC/RS-232) start-up and shut down voltage limits and delays		
Input current	37 Amax (continuous) 75 Amax (5 s)	50 Amax (continuous) 75 Amax (5 s)	37 Amax (continuous) 65 Amax (5 s)
Inrush current	< 30 A		
Output voltage	Nominal 230 VAC sine wave, user programmable 200-240V, floating output		115 VAC sine wave, floating, user programmable 85-130V,
Output frequency	Nominal 50 Hz, user programmable 40 - 70 Hz, crystal locked		Nominal 60 Hz, programmable 40 - 70 Hz, crystal locked
Nominal output power	1000VA / 600W	1200VA / 800W	600VA / 600W
Output current	Nominal 4.4A Short circuit 13 A max 4 s	Nominal 5.2A Short circuit 13 A max 4 s	Nominal 5.2A Short circuit 13 A max 4 s
Efficiency	85 %	83 %	82 %
Load power factor range	Full power rating from 0 inductive to 0 capacitive		
Total harmonic distortion, resistive load	< 2 %	< 2 %	< 3 %
Crest factor	> 3	> 2.7	> 2.7
Static regulation, 0...100% load	+/-3%	+/-3%	+/-5%
Transient recovery	< 0.3 ms	< 0.3 ms	< 0.3 ms
Psofometric noise, input	< 2 mV	< 2 mV	< 2 mV
Isolation	Input-Chassis 1500 VAC (2000 VCD) Input-Output 3000 VAC (4000 VDC) Output-Chassis 1500 VAC (2000 VDC)		
Overload	200 % (1200 W) / 5 seconds Max time can be limited shorter, 110% /60 s is always available Number of restart attempts and delays are user programmable	150 % (1200 W) / 5 seconds	165 % (1000 W) / 5 seconds
Protection	Output current limiting Overload and short circuit proof Input and output fuses		
STANDARDS			
Safety	EN 60950-1		
EMC	EN 55022A, EN61000-6-3, EN61000-6-2 or EN61000-6-1 (EN61000-4-3 radiated immunity according to EN61000-6-1 other immunity standards EN61000-6-2) , ETS 300 132-2, BTNR 2511		
ALARMS, INDICATIONS AND CONTROLS			
LED-Indications	Input ON Output ON Output loading, 4 levels: >5%, >30%, >50%, >80% Overload / Fault		
Relay alarms	2 relay contacts: Fault in system summary alarm (module failure, DC input low etc) Primary supply failure (system with bypass) or Output ON indication (system without bypass)		
Remote monitoring through RS-232 (Remote monitoring software)	Status information: For example input and output voltage, power, temperature, faults etc. Parameter adjustment: For example input voltage limits, output voltage, over load, faults etc.		
MECHANICAL			
Dimensions	See first page		
Connectors in front panel	Input: 50A DC connector, Anderson SB50 6319 or UMA S50 50 A DC Output: Finger protected AC-connector, Wieland ST18/3S2		
Enclosure	Steel casing IP20		
ENVIRONMENTAL			
Operating temperature	0...45 C full power, 45...60 C reduced power, derating -2%/C typically		
Cooling	Natural convection	Forced cooling, monitored redundant fans	Natural convection
Altitude	Full power up to 2000m, derating -2% / 100m, max altitude 3000m		

CONFIGURATIONS

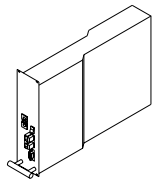

Stand-alone

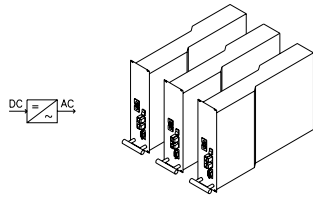

Parallel connection

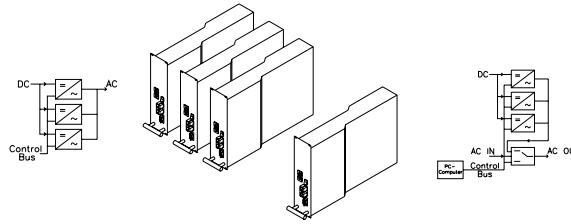

Parallel with external static switch, On-line and Off-line applications

EXPANDING SYSTEM

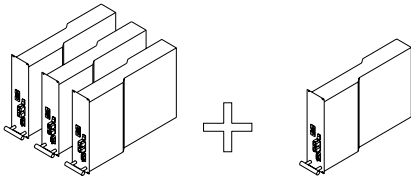

More power needed or unit replacement

No need to shut down system output

1) Connect cables: DC cable, AC cable, System bus

2) Turn new unit on

- Automatically enters system
- Automatically adapts system parameters (voltage, frequency etc.)
- Automatically turns output on if the system output is on

RS-232 AND SYSTEM BUS

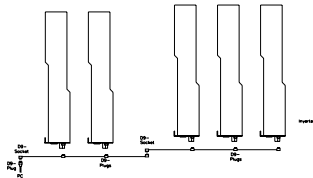

Single 9 pin female D-connector

- Standard 4 pins for RS-232 for communication with a PC
- 2 pins for internal system communication

Single 9-pin flat cable

- male D-connectors for inverters
- one female connector for connecting PC or similar expansion cable

REMOTE MONITORING SOFTWARE

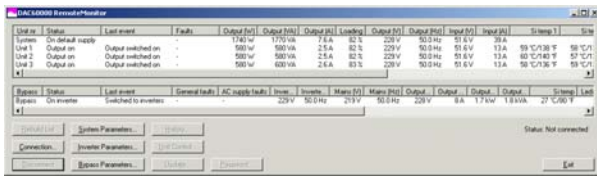

Continuous status information from all units:

- Output on/standby, voltage, current, power, loading per cent
- Input voltage and current
- Internal temperatures, led and button status, faults

Parameter adjustment (without turning system output off):

- Inverter start up and shut down input voltage limits, reaction delays
- Output voltage and frequency, restart attempts after overload shut down
- Bypass synchronising frequency range, accepted mains voltage range etc.

History file reading for last 30-40 events per module

Unit control to remote control or to read diagnostics

Software updates to update or add features for DAC60000 inverters

RELIABILITY

Real redundancy - No single failure may fail the system

No external controller

- No other master slave dependence but synchronising
- If synchronising master fails, next unit starts sending the synchronising data

Rugged system bus structure with galvanic isolation

Automatic bus address configuring

- No need for address setup by user
- No malfunctions because of wrong setup

Self tests and diagnostics

- Full automatic power stage test every time inverter is started
- Continuous monitoring of internal operations
- Error counters (RS-232) for troubleshooting
- Recognising of wrong connections (cable not connected, wrong AC bus polarity)

Recovery and monitoring procedures in hardware and software

- Stands disturbances in system bus
- Stands accidental system bus disconnecting for seconds
- Stands wrong connections of cables
- If one unit fails other units alarm
- Voting procedures for recognising and filtering wrong operation

Automatic fast shut down of failed unit

- Disconnecting from AC bus in 10 ms
- Automatic watch dog restart if processor hangs up
- Unit automatically turns output off if synchronising lost for too long time

Internal history file in each inverter, last 30-40 system and unit specific events

COMPLETE INVERTER SYSTEMS, AC-DISTRIBUTION AND MANUAL BYPASS



19" 6U sub-rack

1...4 Inverters
Static Switch
Manual bypass
AC-distribution



19" 2U panel

Static Switch
Manual bypass
AC-distribution

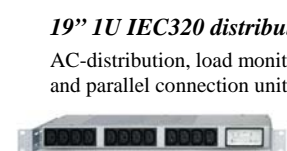

19" 1U IEC320 distribution

AC-distribution, load monitoring and parallel connection units

Please contact Powernet for customized inverter system configurations